

AQUAMASSAGE

BY PierDeco
d e s i g n

PD-845







Owner's manual



AQUAMASSAGE

PD-845



-  Rain shower head with anti-scale jets
-  Neck & shoulder massage waterfall
-  3 anti-scale flat body jets
-  Solid brass handshower
-  Apple cut solid brass handles
-  4 volume controls
-  Integrated niche (Shelf)
-  Thermostatic 1/2" cartridge with safety lock
-  LED lights powered by our Aqua-turbine

HEIGHT	63"
WIDTH	9"

TECHNICAL SPECIFICATIONS

This shower column is easy to install and can be connected to your standard plumbing.

Minimum Pressure : 2.8 bars (40 PSI).

Maximum Pressure : 5 bars (72.5 PSI).

Note: If the water pressure is over 5.5 bars (80 PSI) you will need to install a pressure reducer to the main valve. It should be set to 4 bars (58 PSI) for optimum results.

TEST DATA

Our columns have been subjected to pressure tests up to 8 bar (116 PSI). For your information. To ensure that the water pressure in your home is adequate, you can test the pressure by measuring the water flow rate. In the kitchen turn on the cold water faucet full blast. If you collect 5.5 L or more in 30 sec., your water pressure is probably too high and you should install a water pressure reducer valve downstream of the main shut-off.

FUNCTIONS	L/Min Base	L/Min Standard	L/Min Max
	30 PSI	43 PSI	60 PSI
Waterfall	6.5	7.5	8.5
Rain shower head	7.0	8.0	9.5
Body jets	7.5	8.6	9.5
Handshower	6.9	7.9	9.5
Multiple functions*	15	20	30

*Water consumption is less when there is a diverter

INTRODUCTION

This owner manual will help you to enjoy your new AQUAMASSAGE Shower column as well as show you how to install, clean and maintain it.



WE SUGGEST THAT YOU USE THE SERVICES OF A LICENSED PLUMBER OR CONTRACTOR TO INSTALL YOUR NEW SHOWER COLUMN.

IMPORTANT NOTICE BEFORE INSTALLING THE PRODUCT

- Please take few minutes to review this manual before you start the installation.
- Inspect the product with great care before starting the installation.
- Check if the wall is straight and level and free of bumps.

THERMOSTATIC SHOWER COLUMN

This shower column includes a thermostatic valve. This system will maintain the water temperature in your shower even when there is other water usage in your home. The temperature of the shower column is pre-set at 38°C (100°F) however, you can adjust the water temperature by turning the lever handle. To allow the water in your shower to reach the maximum temperature, you must ensure that the water heater is set to 60°C (140°F).

You will need the following illustrated tools to install the shower.

It is recommended that the installation be done by two people.



LIST OF PARTS AND COMPONENTS IN THE BOX

1. Shower column and shower head
2. Wall brackets (2)
3. Screws (4)
4. Plastic anchors (4)
5. Assembly kit for showerhead connection to the column.
6. Handheld shower with hose 150cm (60»)
7. Wall bracket for handhel shower
8. This shower uses _____ mm volume cartridges.



(2.)



(3.)



(4.)



(5.)

INSTALLATION

1. During the installation manipulate the tools and shower column with great care to avoid damages and scratches. Shut off the water at the main before starting the installation.
2. Step 1 is to connect the shower head to the body of the column. Simply pass the water supply through the hole and then fix the head by means of 4 nuts and bolts supplied in your assembly kit. Connect the shower head water supply to the respective connector on the rough inside the column.
3. We recommend to install the column at 33" (83.8 cm) from the lever handle (thermostatic valve) to the floor. Determine if the height is suitable and appropriate for yourself and the other users.
4. Install the water lines at 30" (76.2 cm) from the floor and leave a gap of 4" (10.2 cm) between the hot and cold water line. Use 1/2" diameter pipe with 90° 1/2" male adaptor (adaptors not included).
5. On the back of the shower column, where the water supply line comes out of the wall, it is important to seal the space between the ceramic and the pipe with silicone to prevent water seepage into the wall.
6. Install each wall bracket at the desired height. Use a pencil and a leveller before drilling each hole, then install the two brackets. (your wall structure may require additional anchors and screws.) Please make sure the bottom brackets don't interfere with the supply lines.
7. Connect the hot and cold flexible stainless steel hoses to the water adaptors previously installed on your water supply line and slide the shower column in place. Do not replace the flexibles for it will automatically void your warranty.
8. Turn on the main water supply line and check carefully for leaks
*******Apply a few thin spots of lear silicone on each side of the shower column to secure it in place.*******

INSTALLATION DIAGRAM

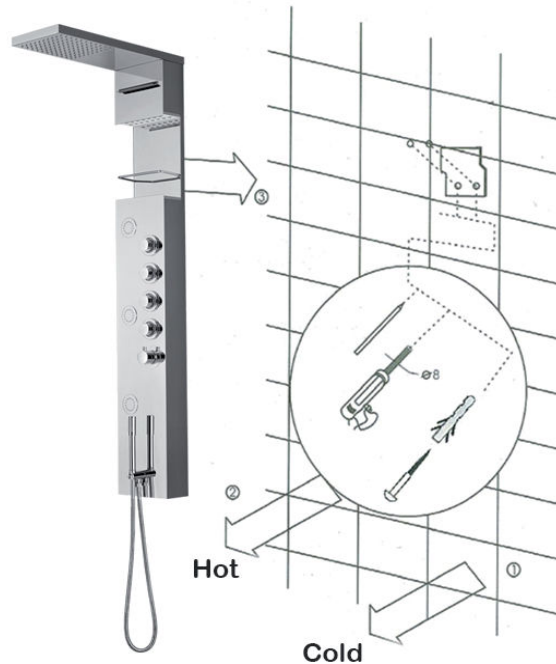

HOW TO SET & USE YOUR NEW SHOWER COLUMN

You can activate more than one function at the time, ex.; body jets and rain shower. However the water pressure will be reduced and the vigour of the jets will be affected.

From top to bottom :Turn the control to the left and the water pressure will increase gradually up to the maximum, the first handle controls the shower head, the second one controls the body jets and the third one controls the handheld shower. However, for all TS (tub & shower) models, the third handle controls the water pressure and transfers the water to the spout diverter, which allows you to fill the bathtub, to redirect the water to your handheld shower or to test the water with your foot.

TEMPERATURE PRESET

The temperature of the shower column is preset at 38°C (100°F).

MAINTENANCE

To preserve the look and finish of your shower column, you should dry the shower column after each use with a dry and clean cloth. Do not leave any soap residue on the surface of the shower column, it can contain acid and acid can burn the rubber injector and the glass shelf. Never use abrasive cream, powder cleaner or steel wool pad on the surface, it can scratch the stainless steel and damage the finish .

HOW TO CLEAN THE JETS

Use a soft bathroom cleaner and a little toothbrush. Spray cleaner directly on the jets and brush every little hole then rinse thoroughly with clean water.

THERMOSTATIC CARTRIDGE MAINTENANCE

The thermostatic cartridge is guaranteed against manufacturing defects, but not against the accumulation of lime caused by water. It is recommended to turn the thermostatic handle completely to the left and to right on a weekly basis to prevent the accumulation lime which can cause the malfunction of the thermostatic cartridge. See the troubleshooting section on page 5 to estimate the problem.

Please see our video on Youtube to follow the instructions in order to maintain your thermostatic cartridge.

[pierdeco.com/youtube](https://www.pierdeco.com/youtube)

TROUBLESHOOTING

PROBLEM	DIAGNOSTIC
Water temperature is not hot enough.	<ol style="list-style-type: none"> 1. Press on the push button on the top of the thermostatic handle and turn counterclockwise. 2. The water heater temperature is set at 60°C (140°F). 3. Make sure that there is no air in the water pipes.
Noise is coming from the water line when the shower column is in function.	<ol style="list-style-type: none"> 1. Look for air pockets in your plumbing . 2. Look for upside-down "U" in all the pipes going to the shower, make sure that they are not kinked or twisted
Water temperature gets increasingly colder.	The problem is probably coming from your water heater, try this little test: Turn on the hot water faucet of the sink and see if the water is hot, if the water is cold the problem is coming from the water heater. the tank may be empty, wait 30 min and try the test again.
Cold water comes out when the faucet is set on hot water.	Check the two stainless steel hoses at the back of the shower column, the hot and cold are probably reversed.
The water pressure is going down gradually.	<ol style="list-style-type: none"> 1. Verify the filters in the gaskets at the water entry as well as on the thermostatic cartridge. 2. Look for upside-down "U" in all the pipes going to the shower, make sure that they are not kinked or twisted.
The temperature is hard to adjust when the thermostatic is turned.	The thermostatic cartridge probably needs to be soaked in a deliming solution. Please refer to the maintenance section on Page 5 of your owner's manual.



ATTENTION

Any warranty will be void and ineffective in the case of a modification of the internal mechanism or any other component of the product. If this troubleshooting guide does not help you to find or fix the problem. Please call : 450-417-3740.

WARRANTY

All AQUAMASSAGE products carry a lifetime warranty against defects in materials and workmanship. The warranty will be applied only if the product is purchased from an authorized AQUAMASSAGE retailer. The AQUAMASSAGE warranty is limited strictly to the original consumer purchaser and the original installation of the product. The warranty is not transferable and is limited to products sold and installed in North-America.



ATTENTION

This limited warranty is void if the product has been moved from its original place of installation, damage due to installation error, product abuse, product misuse, or use of cleaners containing abrasives, alcohol or other organic solvents, whether performed by a contractor, service company, or yourself, normal wear of the finish, the damage is caused by hard water, calcareous deposits or sediments, the damage or loss is sustained in a natural calamity such as fire, earthquake, flood, thunder, electrical storm, etc. are excluded from this warranty.

AQUAMASSAGE and/or PIERDECO is not responsible for any labor or shipping charges, or damages whatsoever incurred in whole or in part from installation, removal, re-installation, repair or replacement of any AQUAMASSAGE product or part, as well as any incidental or consequential damages, expenses, losses, direct or indirect, arising from any cause or costs of any kind related to the product or installation or it was not installed in accordance with AQUAMASSAGE instructions or it has been modified in a manner inconsistent with product shipped by AQUAMASSAGE.

AQUAMASSAGE option to repair or exchange the product under this limited warranty does not cover any labour or other costs of removal or installation. In no event will AQUAMASSAGE or PierDeco design Inc. will not be responsible for any other incidental or consequential damages attributable to a product defect or to the repair or exchange of a defective product, all of which are expressly excluded from this limited warranty.

Mechanical working parts including ceramic disc cartridges for bothside valves and pressure balance, thermo cartridges, stops, diverters etc. all carry our full limited lifetime warranty to the original purchaser. Please note that lime accumulation and deposits caused by water is not covered by this warranty. Please see the maintenance section on page 5 to avoid and/or eliminate lime accumulation in the thermostatic cartridge.

AQUAMASSAGE polished and brushed chrome and stainless steel finishes are warranted for the life of the product to the original purchaser. Normal wear of the finish is not covered by this warranty. For adequately safeguard the polished chrome or stainless steel in good condition, it is important to clean after each use using a soft cloth. Improper maintenance or normal wear of finish is not covered by the warranty.

All electrical components are warranted for five (5) years.

PierDeco Design Inc. reserves the right to make product specification changes without notice or obligation and to change or discontinue certain models. Following a complaint, it will determine after inspection of the product by an authorized agent to repair or replace the product for a similar model. In case of a complaint or to obtain a service under this limited warranty, it is necessary that a demand of service be steered by the retailer from whom the product was bought (we will need the model number of product, a description of the defect, proof of purchase, your name, address and telephone number). The retailer can then forward your complaint to the authorized agent. The retailer can then forward your request to the authorized agent by completing the on-line form at [http:// pierdeco.com / service](http://pierdeco.com/service).

PIERDECO reserves the right to inspect the installation before any replacement or repair of any component. Photos will be required in order to analyse all requests.

Please note that transport costs will be charged to send any part or product.

PIERDECO DESIGN INC.

825 rue Bombardier, suite 7, Mascouche QC J7K 3G7
TEI. : 450-417-3740 FAX : 450-417-3738
<http://pierdeco.com/service>

PierDeco
d e s i g n

PD-845 AquaMassage

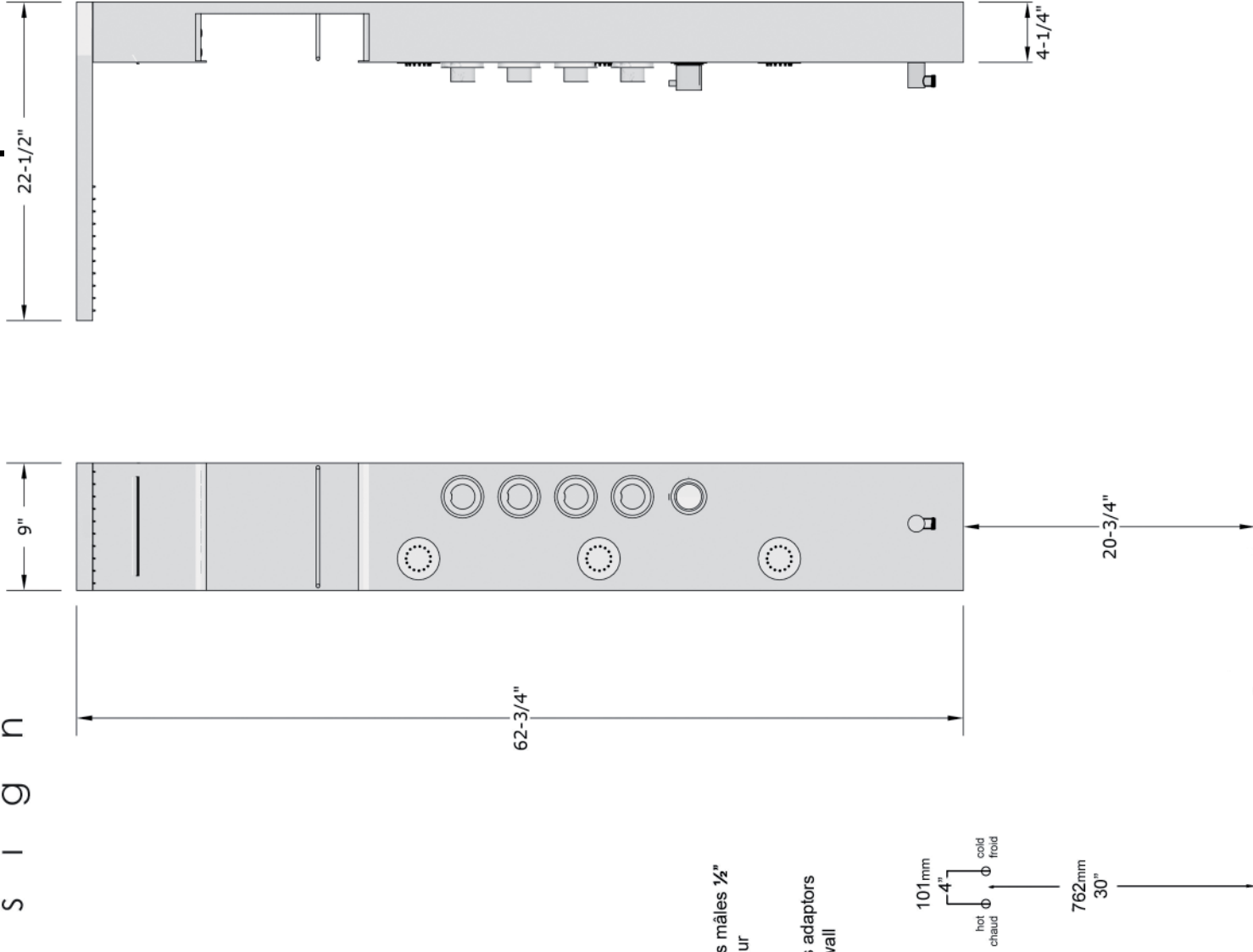

Requiert:
2 adaptateurs mâles 1/2"
sortis du mur

Need:
2 1/2" males adaptors
out of the wall

Products and specifications shown are subject to change without notice.
Les produits et spécifications illustrés sont sujets à changement sans préavis.
v1.0



pierdeco.com