

MODEL NUMBER:

- 1660.144 Water Saving 3-Function Hand Shower

*WaterSense approval pending

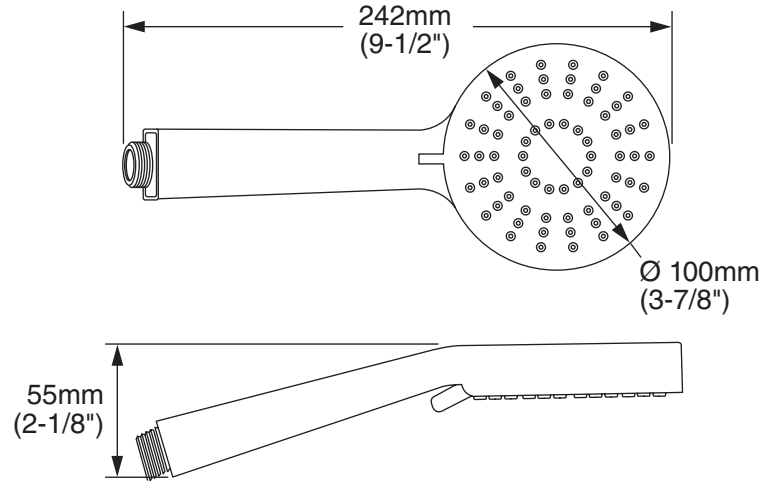

GENERAL DESCRIPTION:

3-Function hand shower. Hand shower adjusts from full spray to full/massage combination to pulsating massage. Includes pressure compensating flow control device. Includes check valve to prevent cross flow of hot and cold water. Easy clean spray nozzles. 2.0gpm/ 7.6L/min. maximum flow rate.

PRODUCT FEATURES:

Variety of Spray Patterns: Allows the user to select the type of spray best suited to their needs.

Pressure Compensating Flow Control Device: Provides consistent flow over a wide pressure range.

Simple Spray Pattern Adjustment: Spray patterns can be changed with a flick of the thumb.

Lightweight, Ergonomic Design: For a sure grip even with wet, soapy hands.

Easy Clean Spray Nozzles: Easily clean lime and calcium buildup. Nozzles will not clog.

SUGGESTED SPECIFICATION
Hand Shower shall have at least 3 spray patterns. Hand Shower shall have a pressure compensating flow control device. Hand Shower shall include check valve to prevent cross flow of hot and cold water. Fitting shall be American Standard Model # 1660.144.____.





CODES AND STANDARDS

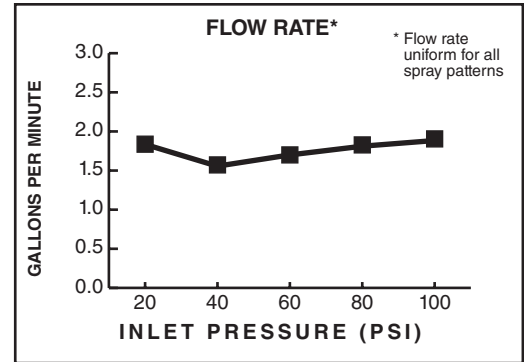

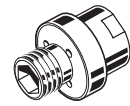

These products meet or exceed the following codes and standards:

ASME A112.18.1
CSA 125.1



Product Number	Description	Finish Options	
		Polished Chrome	Matte Black
		002	243
1660.144	Water Saving 3-Function Hand Shower.		

Hand Shower Accessories	
Product Number	Description
8888.035	59" Metal Shower Hose 
8888.053	79" Metal Shower Hose (Chrome Only) 
1660.400	Vacuum Breaker 
1660.410	Shower Arm Diverter 
8888.096	Shower Arm Bracket 

Hand Shower Accessories	
Product Number	Description
8888.036	Fixed Wall Bracket 
8888.037	Wall Supply 
8888.068	Round Wall Supply 
8888.069	Square Wall Supply 
8888.038	Wall Supply Bracket 