



Tuzio® Flanders Towel Warmer Installation Guide

**Code: W6043 / W6044 / W6046
26.5" x 37" Hardwired**

**Technical Helpline:
Toll-Free 1-877-757-8990
www.icocanada.com**



3005 Saskatchewan Drive
Regina, SK | S4T 1H5

toll free | 1 877 757 8930
tel | 306 757 8941 fax | 306 757 8940

Towel Warmer Installation Procedure



1 Rough-in Requirements (see figure 3)

1. The incoming power feed goes to a deep single gang electrical box (for timer). This electrical box can be located anywhere in the room, although we recommend it be alongside your light switches.
2. A power feed then goes from the timer electrical box to a single gang electrical box (for Towel Warmer). The location of this electrical box governs the location of your Towel Warmer (see fig. 2).
3. Wall studs or plywood backing is required at all bracket locations. See figure 2 for bracket locations.

2 Installation Instructions (see figure 1)

1. Check all items have been received. You should have Towel Warmer, hardwire kit, programmable timer and mounting discs including fixings. Read all instructions before continuing.
2. Fix mounting discs "A" using the screws provided and in locations as shown on figure 2.
3. Mount towel warmer and slide brackets "B" over mounting discs "A".
4. Fasten Towel Warmer using set screws "C" to lock mounting discs "A" into brackets "B". Ensure the Towel Warmer is firmly and safely fixed.

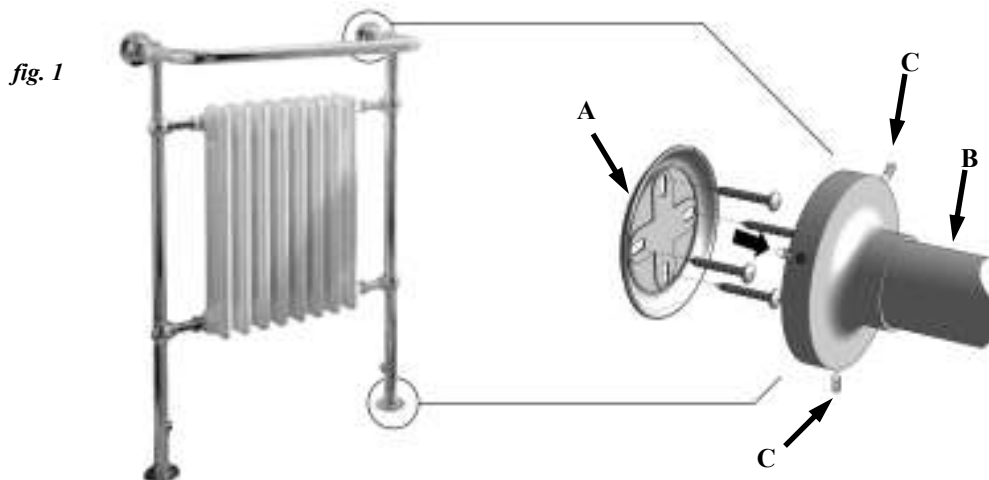

3 Hardwire

Do not connect the Towel Warmer to the power supply until all instructions have been read and installation carried out in accord with them. The heating element is 150W 110V. The element conforms to UL standards and the unit to CSA standards (File ref: 229718). Ensure the CSA label is visible. **TURN OFF POWER SUPPLY BEFORE PROCEEDING.**

1. Feed the electrical cord located at the side of the Towel Warmer first through the round tube and then through the cover plate.
2. Complete all electrical connections as shown in figure 3.
3. Fit tube over Towel Warmer element sleeve until it meets the hexagonal chrome collar.
4. Push cover plate onto tube.
5. Screw cover plate to electric box with the enclosed screws. Adjust where necessary.

Warning: In case of damage or failure of the Towel Warmer the unit should be returned to the manufacturer or their distributor. The warranty of 1 year on the heating element and 5 years on the Towel Warmer is NOT VALID in case of improper use or installation. Product is designed for use within Canada and the United States only.



Specifications & Drawings



Model #	Description	Finish	Weight (lb)	Element Size	Output	WxH (mm)	WxH (Inches)	Metal Type
W6043	Flanders Electric Hardwire	Chrome	64.0	300W	3349Btu	675 x 940	26.5" x 37"	Mild Steel
W6044	Flanders Electric Hardwire	Brushed Nickel	64.0	300W	3349Btu	675 x 940	26.5" x 37"	Mild Steel
W6046	Flanders Electric Hardwire	Polished Nickel	64.0	300W	3349Btu	675 x 940	26.5" x 37"	Mild Steel

Heating Element Specifications: 300 watt, 17.75" long, 120 volt, 60 Htz, IP55 cord, ULC approved

Material Specifications: Brass Tube Diameter 1.25" x 0.03" (31.8mm x 1mm) tested to 11 bar and Mild Steel - Din 2394 Quality - ST34-2KB

Warranty: Towel Warmer: 5 years, Heating Element: 1 year, Programmable Timer: 2 years

Fixings: Screws, and Allen Key (if needed) are included

Heating Element Location: Right-hand side of bottom horizontal bar unless specified otherwise.

Care & Maintenance: A periodic wash using warm water and a soft cloth will retain the high quality finish of your towel warmer for many years to come. ON NO ACCOUNT should any household bleaches, detergents, abrasive polishes, steel wool or other cleaning agents be used on this item.

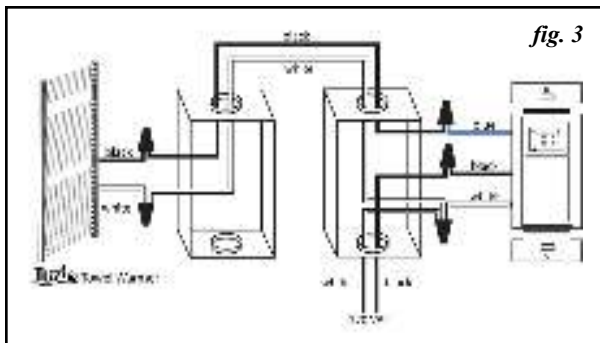
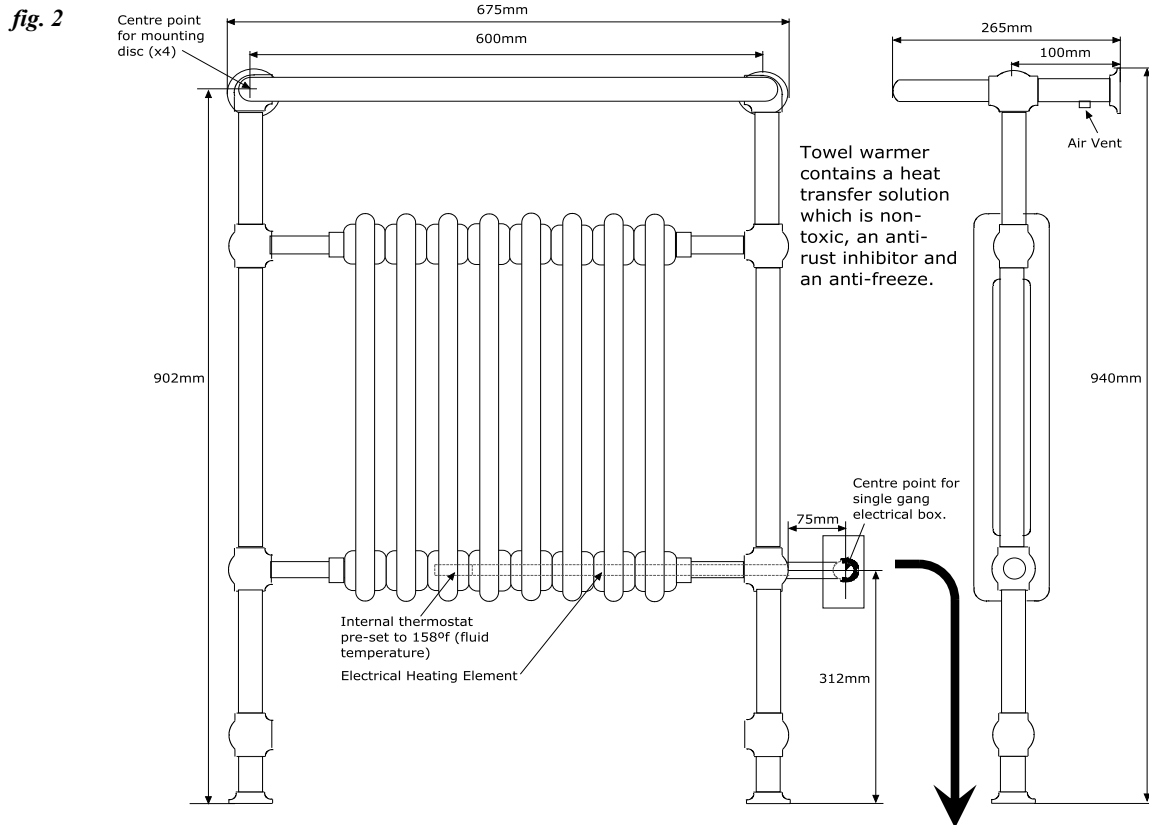

Timer Installation Procedure



1 Installation

- 1 Install the timer as shown in figure 3.
- 2 Apply power at the circuit breaker.

2 Power On

- 1 Pry the switch door open from the bottom using a small screwdriver.
- 2 Ensure the **ON/OFF** selector is set to **ON**.
- 3 Reset the switch using a paperclip. **0:00** and **MO** will flash.

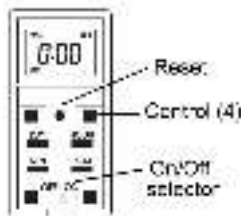

3 Setting the Clock

- 1 Set the time using the **HOUR** and **MIN** buttons.
- 2 Set the day by using the **DAY** button.
- 3 Press one of the control buttons or close the switch door to return to normal operation.

4 Selecting the Operating Mode

The programmable switch has 2 operating modes: manual (**MAN**) and automatic (**AUTO**). To switch mode, press the timer door for 3 seconds.

Manual Mode

The programmable timer operates as a regular switch. Briefly press the switch door to turn the towel warmer On or Off. The mode (**MAN**) and state (**ON** or **OFF**) are displayed.



Automatic Mode

The programmable timer follows the programmed schedule. The mode (**AUTO**), state (**ON** or **OFF**) and current program number are displayed. To temporarily override the programmed schedule, briefly press the switch door. The new state (**ON** or **OFF**) will flash to show that this state is temporary. The override remains in effect until you press the timer door again or until the beginning of the next program.



5 Programming

You can set up to 7 programs. To set a program, you need to enter its start time (**ON**) and its end time (**OFF**).

- 1 Pry the timer door open using a small screwdriver.

- 2 Press the **PGM** button to display a program and its On or Off time. For example, when you first press **PGM**, program number 1 (**P1**) and its On time (**ON**) will appear. **:-:** will appear instead of the time if the program is not set (inactive).

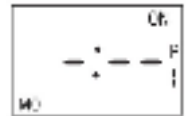

- 3 Press the **DAY** button to select the day to which you want to apply the program. *NOTE: If you want to apply the program to every day of the week, press **DAY** until all the days are displayed. (This still counts as 1 program, not 7)*

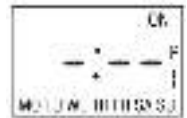

- 4 Press the **HOUR** and **MIN** buttons to set the **ON** time (time when you want the towel warmer to turn on)
- 5 After you have programmed the **ON** time, press the **PGM** button to display the **OFF** time (time when you want the towel warmer to turn off).
- 6 Repeat steps 3 through 5 to program the **OFF** time. If the program **ON** time is set for every day of the week, the program **OFF** time will automatically be set for every day.
- 7 To set another program, repeat steps 2 through 6. Programs that are not set will remain inactive.
- 8 Press one of the control buttons or close the timer door to return to normal operation.

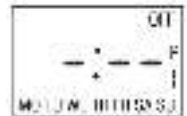

Clearing a Program

Press the **PGM** button until the desired program is selected. Hold the **PGM** button for 3 seconds. **:-:** appears when the program is erased.

6 Troubleshooting

Blank display	<ul style="list-style-type: none"> • Verify circuit breaker at main panel. • Ensure the ON/OFF selector is at ON. • Reset the switch using a paper clip.
Programs do not run as expected	<ul style="list-style-type: none"> • Make sure the switch is properly programmed. • Note that :-: indicates an inactive program, 00:00 indicates midnight.