

OSLO COLLECTION QUADRUPLE ROBE HOOK 144134-4

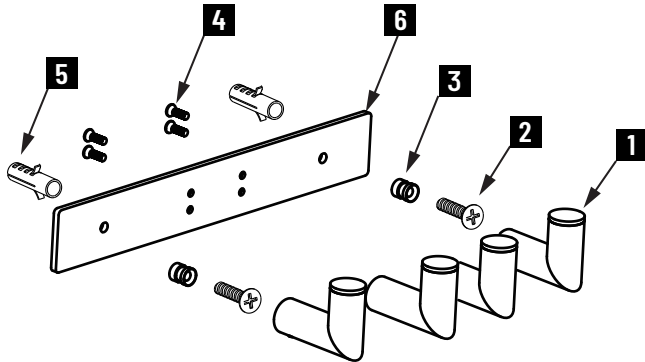

- 1. Robe Hook x 4
- 2. Wall Screw x 2
- 3. Bracket x 2
- 4. Sunk Screw x 4
- 5. Plug x 2
- 6. Backing x 1

Tools required for installation

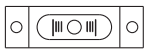

Level

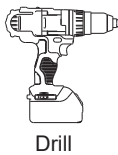

Drill



Pencil

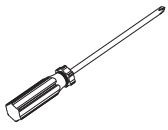

Screwdriver



Hammer

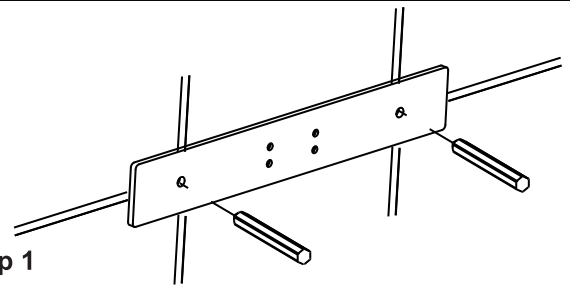

Step 1

Position the backing on the wall and mark holes with pencil.
NOTE: Smooth surface at the front side

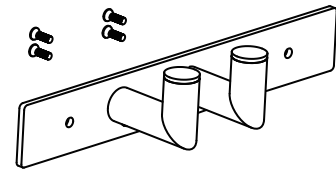

Step 2

Divide the 4 hooks by 2X side hooks and 2X middle hook,
and fix the 2 middle hook by sunk screws

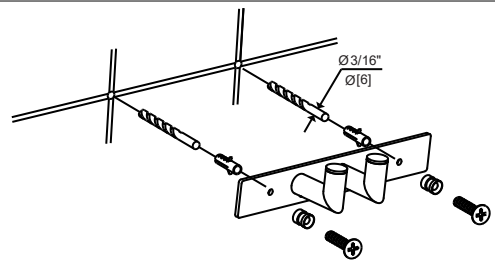

Step 3

Using the wall screws through the brackets & side holes on
the backing, tighten the screws on the wall

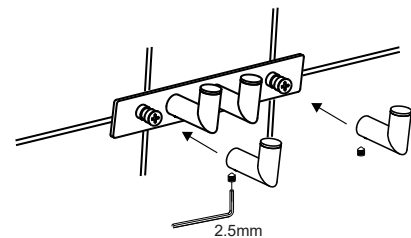

Step 4

Fix the side hooks on the brackets, and tighten the set
screws using Allen key provided