



# TR02Q-

Finish Suffix

## Clicker® Waste/Overflow Trim Kit

### Description:





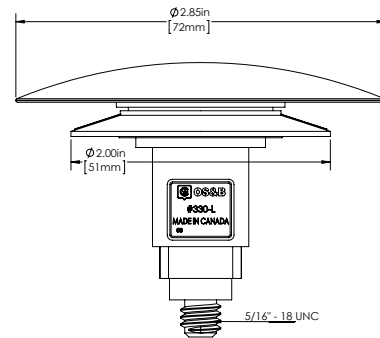
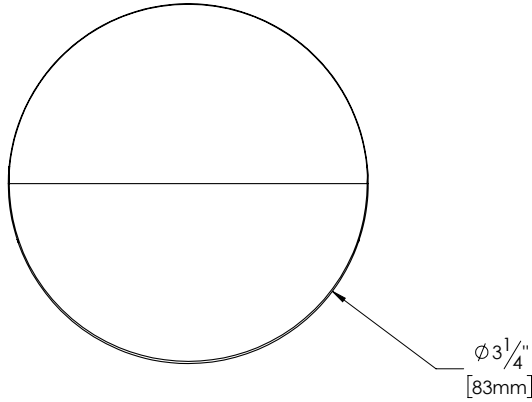
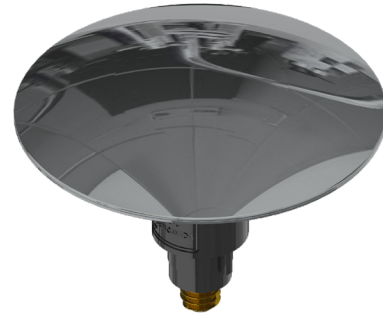

Clicker® Trim Kit for Bath Waste/Overflow Rough-ins

### Features:

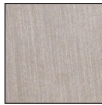
- Round Slide-on Faceplate.
- Coarse Thread (5/16") Clicker® Closure.

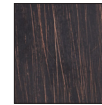

### SELECT FINISH SUFFIX BELOW AND TRANSPOSE ABOVE:

							
<b>BCP</b> (Brass Chrome Plated)	<b>BN</b> (Brushed Nickel)	<b>CP</b> (Chrome Plated)	<b>MBL</b> (Matte Black)	<b>POLN</b> (Polished Nickel)	<b>PB</b> (Polished Brass)	<b>VB</b> (Venetian Bronze)	<b>W</b> (White)
<input type="checkbox"/>	<input type="checkbox"/>	<input type="checkbox"/>	<input type="checkbox"/>	<input type="checkbox"/>	<input type="checkbox"/>	<input type="checkbox"/>	<input type="checkbox"/>

### Oakville Stamping and Bending Ltd.

2200 Speers Road. Oakville, ON. Canada. L6L 2X8.

T. 905.827.0320 or toll free 1.877.314.6040 F. 905.827.6375 or toll free 1.877.827.6040.

All rights reserved. OS&B™ reserves the right to change product specifications and material or discontinue models without notice.

**www.osb.ca (Canada) www.osbplumbing.com (USA)**