



3-way Type T/P coaxial complete valve
EDTM45+



Specifications

Composition

- TEDTM45+C - 3-way Type T/P coaxial valve trim
- R45 - 3-way Type T/P coaxial valve rough

Available colors

- C : Chrome
- BN : Brushed Nickel (PVD)
- PN : Polished Nickel (PVD)

Available flows

- 24 L/min, 6.3 gpm (US) 60psi
- Type TP - For use with shower heads rated at 7L/min (1.8 gpm) or higher

Certifications

- CSA B125.1
- ASME A112.18.1
- ASSE 1016
- CMR248 Approval

cUPC®

Warranty

This **Riobel Inc.** product you have purchased carries a Limited Lifetime Warranty on the chrome, PVD finish, blacks and all working parts and is guaranteed from the initial purchase date against all manufacturing defects. All other finishes, including plastic components, are guaranteed for one year. All electric and/or electronic parts are covered by a 5-year limited warranty.

Customer Service

Ontario, West Canada : 888-287-5354 Quebec, Maritimes, United States : 866-473-8442

2020.06.11



3-way Type T/P coaxial valve trim
TEDTM45+

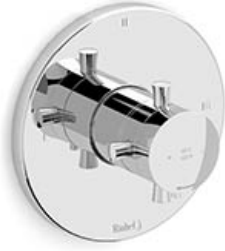

Specifications

Descriptions

- 6 positions (OFF, 1, 1 and 2, 2, 2 and 3, 3) share
- Trim only
- Thermostatic/pressure balance coaxial cartridge with check valves
- R45, R45-SPEX or R45-EX rough required to complete

Available colors

- C : Chrome
- BN : Brushed Nickel (PVD)
- PN : Polished Nickel (PVD)

Certifications

- CSA B125.1
- ASME A112.18.1
- ASSE 1016
- CMR248 Approval

cUPC®

Warranty

This **Riobel Inc.** product you have purchased carries a Limited Lifetime Warranty on the chrome, PVD finish, blacks and all working parts and is guaranteed from the initial purchase date against all manufacturing defects. All other finishes, including plastic components, are guaranteed for one year. All electric and/or electronic parts are covered by a 5-year limited warranty.

Customer Service

Ontario, West Canada : 888-287-5354 Quebec, Maritimes, United States : 866-473-8442

2020.06.11



3-way Type T/P coaxial valve rough
R45



Specifications

Descriptions

- TXX45XX or TXX47XX trim required to complete
- ½" inlet male NPT or sweat
- Service valves
- Rough only
- Three ½" outlets male NPT or sweat
- Test cap

Available colors

- :

Certifications

- CSA B125.1
- ASME A112.18.1
- ASSE 1016
- CMR248 Approval

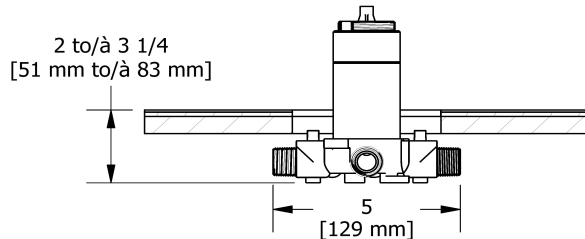
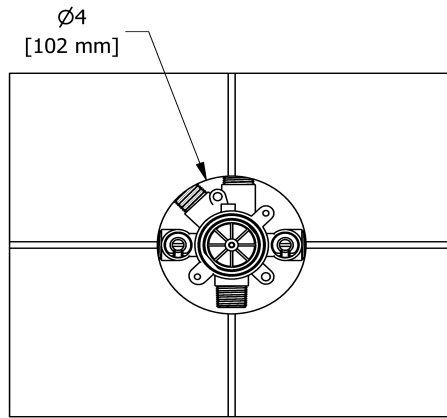

Sizes, models and finishes may differ from those presented.

Warranty

This **Riobel Inc.** product you have purchased carries a Limited Lifetime Warranty on the chrome, PVD finish, blacks and all working parts and is guaranteed from the initial purchase date against all manufacturing defects. All other finishes, including plastic components, are guaranteed for one year. All electric and/or electronic parts are covered by a 5-year limited warranty.

Customer Service

Ontario, West Canada : 888-287-5354 Quebec, Maritimes, United States : 866-473-8442