





Butler 30" Apron Front Single







Model Code: BLC686

Included Accessories

 WK-06-40 CUPC	 CARE KIT	

Optional Accessories

*accessories only fit with rebated edge installation

 DGC-686	 COC-20	 DRC007
 CBB1616C	 ASC406	 DTC-18

Dimensions

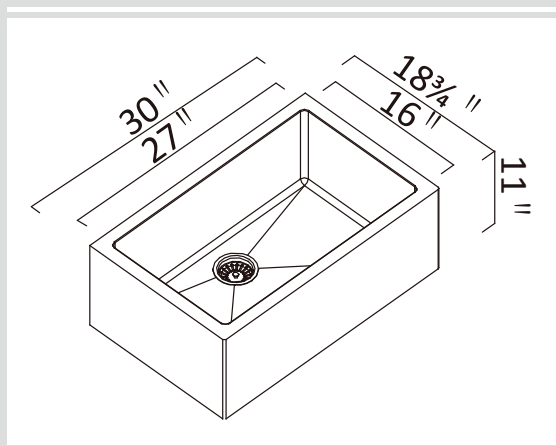

Specifications

Description	Large Single Bowl Apron Front Sink
Overall Sink Size	30" x 18 3/4" x 11" deep
Bowl Dimensions	27" x 16" x 10" deep
Installation	Undermount
Thickness	16 ga
Material	Stainless steel SUS304

Installation

Fixings	No clips provided
Template	zomodo.ca/product/blc686
Min Cabinet Size	30"
Waste Holes	1 x 3 1/2" round Compatible with waste disposal
Sealing Strip	N/A

Plumbing

Waste Fittings	1 x (3 1/2" x 1 1/2") basket waste included
----------------	---

Packaging

Carton Type	Single Carton
Gross Weight	23 lbs
Carton Size	32 1/4" x 21 1/8" x 13 3/8"

SURFACE FINISH



Satin

WASTE KIT

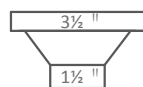

MATERIAL



Stainless Steel

INSTALLATION OPTIONS

See document below for installation instructions

PROFILE



Corner

Limited 25 year Warranty: Zomodo Stainless Steel Sinks: Décor Living Innovations Inc. hereafter referred to as Décor, is pleased to offer a limited 25 year warranty with all Zomodo sinks used in normal domestic installations. Décor warrants its sinks to be free from all manufacturing defects in material and workmanship. Décor will repair or replace (at Décor's discretion), at no charge, excluding labour, any sink supplied by Décor that is proven to be defective under normal use. Please visit www.decor.ca to see full Terms & Conditions.

Zomodo Product Certification: All Zomodo pressed sinks and waste kits sold in Canada are CSA approved. All Zomodo sinks are tested and exceed the requirements of CSA standard ASME A112.19.3-2008/CSA B45.4-08 - Stainless steel plumbing fixtures. Our Waste kits are tested and exceed the requirements of cUPC Standard. Our faucets are tested and exceed both cUPC and CSA standards.

BUTLER SINK

INSTALLTION INSTRUCTIONS

The Zomodo Butler sinks can be installed in various ways. The sink must always be undermounted, however the alignment of the bowl wall relative to the countertop edges has three options.

The diagrams show the three different options:

- A. Overhang
- B. Aligned
- C. Reveal (rebate)

The sink can also be installed with either the outer-front wall aligned with the cabinet doors, or set forward of the cabinets doors.

1. Aligned: Shown in Diagram A and designated by mark "X1"
2. Forward: Shown in Diagram B & C and designated by mark "X2"

The front wall of the sink should not extend further than the front edge of the countertop, Refer diagram D X3

The sink must also be positioned to leave a minimum of 4" between the outer-rear edge of the sink and the wall. This will provide enough space for the installation of a backsplash and for the faucet lever to be fully actuated with ease. Refer Diagrams.

The base cabinet that supports the Zomodo Butler sink should be at such a height to enable the sink to slide under the countertop. The Butler sink has 1" horizontal under-side flanges running front-to-back which will rest on the base cabinet. Apply a liberal amount of silicon on the base cabinet in the areas that the flanges will rest. The distance between the underside of the countertop and the top of the base cabinet should be slightly larger than the sink height. Approximately 1/16" is recommended. When the sink is installed (and before the silicone sets) the sink should be centred and the desired bowl wall/countertop edge alignment achieved.

