

Panama App 55" Prep Sink

Model Code: PPC1200

Included Accessories



Included Insert Accessories



Dimensions

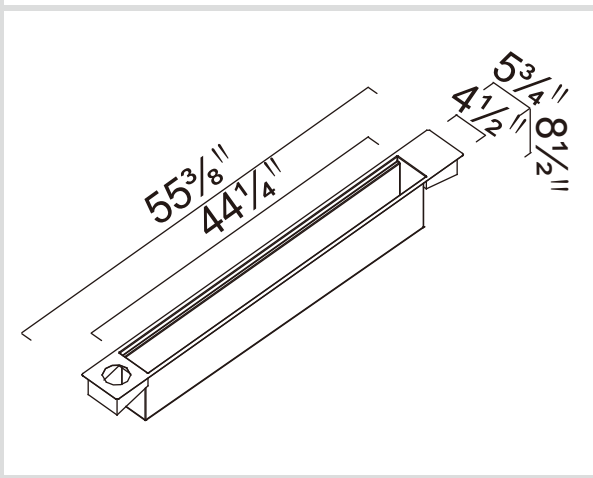

Specifications

Description	Single bowl, Sink
Overall Sink Size	55 ³ / ₈ " x 5 ³ / ₄ " x 8 ¹ / ₂ " deep
Bowl Dimensions	44 ¹ / ₄ " x 4 ¹ / ₂ " x 8 ¹ / ₂ " deep
Installation	Inset
Thickness	18 ga
Material	Stainless steel SUS304

Installation



Fixings	Inset clips supplied
Template	CAD on request
Min Cabinet Size	58"
Waste Holes	1 x 2 ³ / ₄ " round Compatible with waste disposal
Sealing Strip	N/A



Plumbing

Waste Fittings	1 x (2 ³ / ₄ " x 1 ¹ / ₂ ") basket waste included
----------------	--

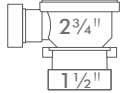
Packaging

Carton Type	EPS protection & Carton
Gross Weight	36.8Lbs
Carton Size	59" x 9" x 11 ⁵ / ₈ "
Package	1

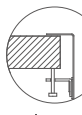
SURFACE FINISH  Scotchbrite	WASTE KIT  2 ³ / ₄ " 1 ¹ / ₂ "	MATERIAL  Stainless Steel
---	---	---

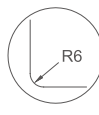
INSTALLATION OPTIONS  Inset	 Flush-mount	PROFILE  Horiz
---	--	--

Limited 25 year Warranty: Zomodo Stainless Steel Sinks: Décor Living Innovations Inc. hereafter referred to as Décor, is pleased to offer a limited 25 year warranty with all Zomodo sinks used in normal domestic installations. Décor warrants its sinks to be free from all manufacturing defects in material and workmanship. Décor will repair or replace (at Décor's discretion), at no charge, excluding labour, any sink supplied by Décor that is proven to be defective under normal use. Please visit www.decor.ca to see full Terms & Conditions.

Zomodo Product Certification: All Zomodo pressed sinks and waste kits sold in Canada are CSA approved. All Zomodo sinks are tested and exceed the requirements of CSA standard ASME A112.19.3-2008/CSA B45.4-08 - Stainless steel plumbing fixtures. Our Waste kits are tested and exceed the requirements of cUPC Standard. Our faucets are tested and exceed both cUPC and CSA standards.